



***Conveyor Chains,
Modular Belts and
Components***



CONSIDER IT SOLVED.™

History

- Founded in 1985, System Plast™ is a global supplier of quality steel and plastic conveying chains, modular plastic belts, conveying components, custom machined plastic and mounted bearings.
- In 2005, System Plast acquired USA based Solus Innovations which offered the lead brands of Valu Guide® conveying components and Nolu® machined plastics.
- Acquired by Emerson in 2008, and afterward by Regal Beloit in 2015, System Plast™ is now part of Power Transmission Solutions, a business unit of Regal Beloit Corporation and offers the broadest line of conveying components available.

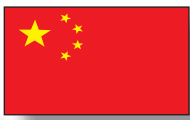

Today

System Plast is a global leader in high quality steel and plastic conveyor chains, modular plastic belts, and industry leading conveying components with manufacturing and service centers located strategically around the world.

Continuous improvement remains a System Plast focus with a drive towards assisting customers achieve Sustainability while lowering their Total Cost of Ownership. Backed by extraordinary technological capabilities and resources, Emerson continues the System Plast culture of innovation in providing conveying components solutions for diverse material handling applications.

This brochure provides an overview of the many quality conveying solutions offered by System Plast. If by chance you don't find your ideal selection, please contact your local System Plast sales office as custom engineered solutions are designed on a daily basis.

Table of Contents

Conveying Chains, Modular Plastic Belts and Sprockets

Steel Conveying Chains.....	4-5
Material Selection Information.....	6-7
Plastic Conveying Chains.....	8-11
Modular Plastic Belts and Chain-Belts.....	12-14
Molded and Machined Sprockets	14

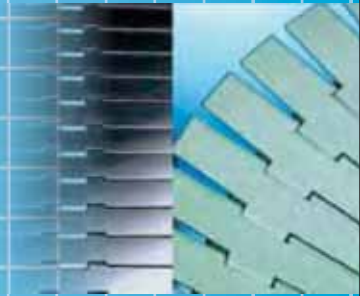

Conveying Components

Nolu® Plastic Information.....	15
ValuTrac® and Magnetic Corner Tracs.....	17
Transfer Plates and Return Guide Components.....	17
Valu Guide® Rails, Clips and Clamps	18
Wearstrips and Extrusions.....	18
Bead and Roller Guide Products	18
SpeedSet, Plastic and Metal Brackets	19
Bracket Knobs and Spacers, Cross Blocks	19
Round and Square Tube Ends	19
Light, Medium and Heavy Duty Levelers in Plastic and Stainless Steel.....	20
Vibration Pads, Post Caps and Side Supports.....	20
Support Bases, Ratchet Handles and Hinges	21
Roll-Tech Mini Conveyors, Rollers and Return Rollers	21
Bearing Supports	22
Self Aligning Bearings and Bearing Caps.....	22
Valu Guard™ Enclosures and Guard Systems	22

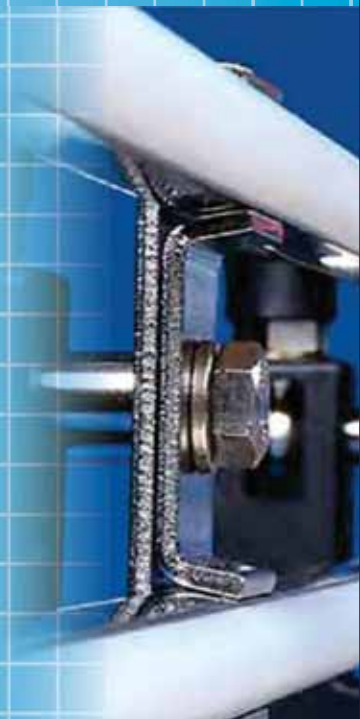

On-Line Tools

.....	23
-------	----





Steel Conveying Chains

System Plast™ offers a complete family of high quality steel chains for a variety of applications. Straight running and side-flexing models are available in multiple widths and steel types to accommodate a diverse range of conveying needs.

Multiple material types allow for varying strength and corrosion resistance:

- C45 carbon steel provides high mechanical strength in areas where corrosion protection is not required
- Standard 430 grade ferritic stainless steel offers affordable corrosion resistance and good mechanical strength
- Austenitic 304 grade stainless steel provides the best corrosion and acid resistance in our steel chain family. This is a non-magnetic steel featuring 18% chrome and 8% nickel
- Extra Plus 400 series high performance stainless steel provides excellent corrosion resistance and surface hardness making it ideal for high speed applications. Our **Speed-Line** models offer minimal gaps and excellent surface finish for optimum product stability.
- System Plast's exclusive HB vacuum hardened pins are also available on select 400 series and **Speed-Line** models. HB pins provide unmatched wear characteristics creating exceptional chain life by minimizing chain stretch.

Most models are available in 3.25" to 7.5" widths for straight running or side-flexing applications.

A variety of side-flexing models are available depending on the type of retention method desired:

- Tab guide models are popular and offer a very secure retention method. Tabs bent outward left and right ride in the curve track and provide excellent guidance and secure chain retention.
- Bevel guide models offer retention via an 8° outward bevel. This bevel rides on the inner and outer curve tracks providing a secure retention of the chain.
- Magnetic retention models eliminate the bevel or tab design and are held in place via magnets embedded in a magnetic curve. This allows for easier curve cleaning and maintenance without disassembling the chain.

All of our steel chains are manufactured to high quality standards on fully automated machinery to provide tight tolerances, optimum performance and excellent surface finishes.

Recommended for extremely abrasive conditions or high load areas where increased chain strength is required

812, 815

Straight Running



Widths ("): 3.25, 4, 4.5, 6, 7.5
Materials: C 45 hardened steel, 400 and 304 series stainless steel

881

Side Flexing



Widths ("): 3.25, 4.5, 7.5
Materials: 304 series stainless steel

881MO

Speed-Line

Side Flexing



Widths ("): 3.25
Materials: 400 series stainless steel

815

Speed-Line

Straight Running

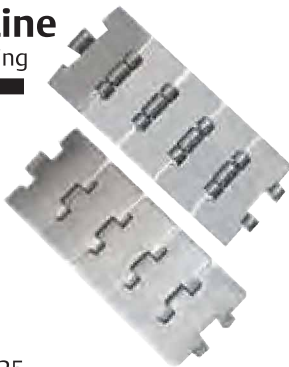

Widths ("): 3.25
Materials: 400 series stainless steel

881 TAB

Side Flexing



Widths ("): 3.25, 4.5, 7.5
Materials: 304 series stainless steel

8810

Side Flexing



Widths ("): 3.25, 4.5, 7.5
Materials: 400 series stainless steel

881M, 881MO

Side Flexing



Widths ("): 3.25, 4.5, 7.5
Materials: 400 series stainless steel

8810 TAB

Side Flexing



Widths ("): 3.25, 4.5, 7.5
Materials: 400 series stainless steel

Thermoplastic Solutions to Conveying Needs

All chain materials are NOT created equal!

System Plast™ gives you the options needed to make the right choice. Thermoplastic material choices, outlined in the chart below, offer solutions for many conveying needs. The New Generation™ (NG™) chain has become a star performer in the beverage industry due to its lower wear rate, lower friction, and lower noise levels. If you have any questions when selecting your chain or belt material, please contact our Application Engineering Group for assistance.

- ★ Good
- ★★ Better
- ★★★ Best



LF
low friction



XPG
extra performance

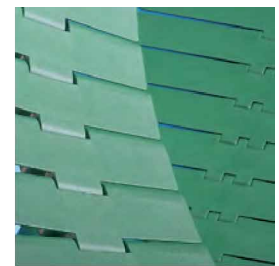

NG
new generation

Higher conveying speeds

Typically beverage filling has higher conveying speeds. Higher speeds require specialized materials.

★

★★

★★★

Coefficient of friction

Low horsepower requirements such as small box conveyors can benefit from reduced chain drag.

★

★★

★★★

Wear life

Abrasive environments require chains with longer wear characteristics.

★

★★

★★★

Reduced noise

Sound levels can be a health or safety problem in any conveying situation.

★

★★

★★★

Higher operating temperatures

NG can be an alternative to steel chains in some hi-temp dry running applications such as shrink tunnels and dryers.

★

176° F

★

176° F

★★★

248° F

Breaking load

Conveying applications involving heavy loads may need to move to stainless steel if mechanical limits are exceeded.

★★★

★★★

★★

Engineered to Perform



Operating factors effect chain life.

System Plast™ conveyor chains are made to high quality and performance standards. Wear resistance, mechanical strength, operating temperature, coefficient of friction — all of these factors, and more, are considered when formulating a conveyor chain material. Based on laboratory research and extensive field experience, System Plast has developed an unprecedented range of chains that provide market leading performance.

Quieter Running

Noise levels compared to stainless steel chain.

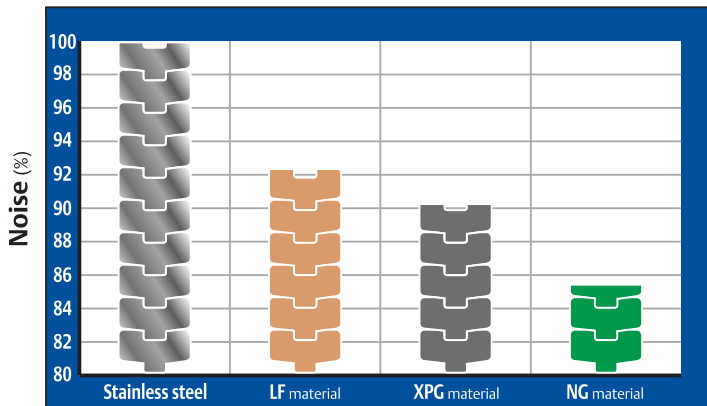

Less Friction

Coefficient of friction between chains and conveyed object materials.

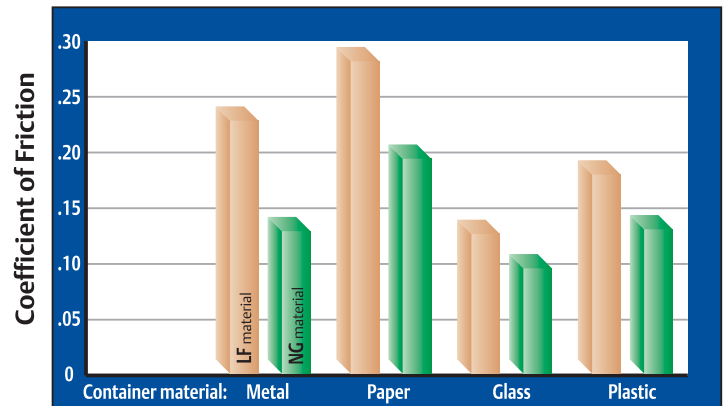

Less Chain Wear

1 liter glass bottles, high speed, dry operation

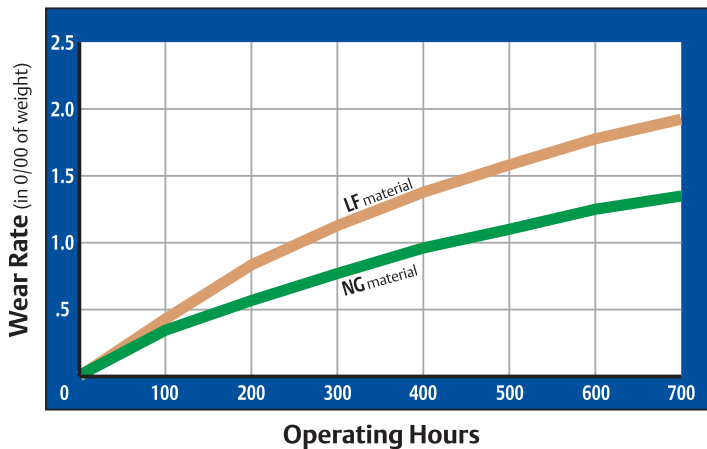

Lowest Available Friction

Coefficient of friction between chains and wear strips (high speed).

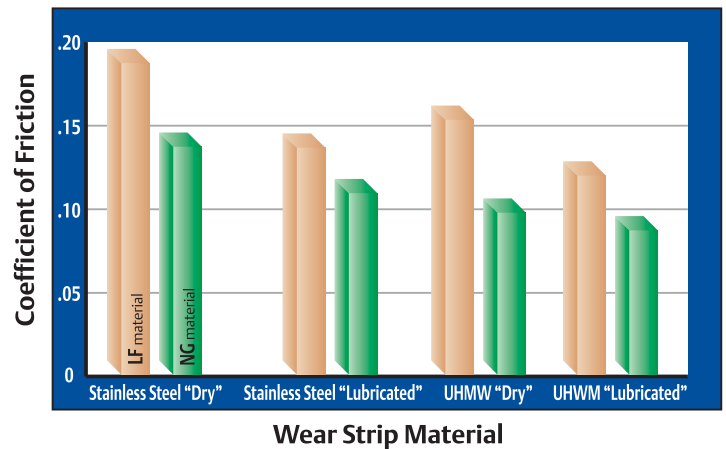



Plastic Conveying Chains & Modular Belts

System Plast™ offers an extensive line of quality plastic conveying chain and modular plastic belts to provide solutions for a variety of standard and challenging conveying needs. Multiple resin materials are offered and can be selected to best suit the application. Our New Generation™ (NG™) proprietary low friction resin provides a lower coefficient of friction than standard acetal materials. Its reduced friction characteristics enable it to run without lubrication in many conveying applications. This creates the opportunity for sustainable savings by reducing or eliminating plant water/dry lubrication systems in addition to enabling reductions in energy use and noise.

Plastic Conveying Chains are offered in multiple families with a variety of features that provide solutions for a wide range of conveying needs:

- Widths range from 3-1/4" up to 12" in our one-piece and two-piece families and are available in straight running or side-flexing versions depending on model.
- Side-Flexing chains are offered in standard tab retention, bevel retention or magnetic retention. Magnetic chain eliminates tabs & bevels thus providing easier curve cleaning and maintenance as disassembly is not required.
- Specialty models are also offered to provide solutions throughout the plant: Gripper Chain for bottle and can elevators; Low Back Pressure for reduced product accumulation pressure; Rubber Top for incline/decline product transport and Multiflex/Crate Conveyor chain for Dairy applications or crate conveyance.

Modular Plastic Belts provide the capability for wider conveying surfaces in addition to increased load ratings versus chain. Our broad offering of standard and heavy duty models provide a multitude of product conveying solutions:

- Imperial widths of 3" to 120" and metric width models from 85mm to 3400mm, depending on model, ensures global customer needs are met.
- Straight running and side-flexing variants provide application flexibility for total plant coverage.
- In addition to standard flat top versions specialty models such as Flush Grid, Rubber Top, and Low Back Pressure are offered to solve unique conveying needs.

Most models are available in multiple materials such as Low Friction (LF) acetal, Extra Performance (XPG) acetal, or our exclusive low friction New Generation™ (NG) resin. See pages 6-7 for more detailed information concerning material types.

High quality molded and/or machined sprockets in a variety of teeth and bores sizes are also offered for all conveying chain and modular plastic belt products.

Our broad offering of straight and side flexing chains provide conveying solutions for your entire plant needs

820
Straight Running



Widths ("): 3.25, 4, 4.5, 6, 7.5
Materials: **LF** **XPG** **NG**

821
Straight Running



Widths ("): 7.5, 10, 12
Materials: **LF** **XPG** **NG**

879 TAB, 880 TAB
Side Flexing



Widths ("): 3.25, 4.5
Materials: **LF** **XPG** **NG**

831
Straight Running



Widths ("): 3.25, 4.5, 7.5
Materials: **LF** **XPG** **NG**

878 TAB
Side Flexing



Widths ("): 3.25, 4.5
Materials: **LF** **XPG**

882, 882M
Side Flexing



Widths ("): 4.5, 7.5, 10
Materials: **LF** **XPG** **NG**

828
Straight Running



Widths ("): 3.25
Materials: **LF** **XPG** **NG**

879, 879M, 880, 880M
Side Flexing



Widths ("): 3.25, 4.5
Materials: **LF** **XPG** **NG**

882 TAB
Side Flexing



Widths ("): 4.5, 7.5, 10, 12
Materials: **LF** **XPG** **NG**

LBP Chains

High Load Accumulation Areas

Rubber Top and Gripper Chains

Incline/Decline or Elevator needs

LBP 821, LBP 8257

Straight Running

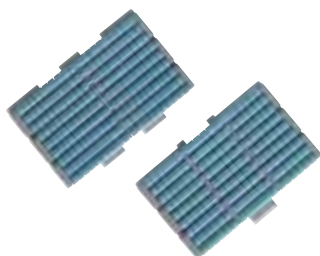

Widths ("): 7.5, 10, 12
Materials: **LFG**

LBP 882 M

Side Flexing



Widths ("): 7.5, 10, 12
Materials: **LFG**

831 VG

Straight Running



Widths ("): 3.25
Materials: **NGD**

882MVG, 882TABVG

Side Flexing

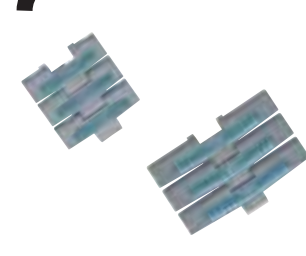

Widths ("): 7.5, 10, 12
Materials: **NGD**

LBP 831

Straight Running



Widths ("): 3.25, 4.5
Materials: **LFG**

LBP 878 TAB

Side Flexing



Widths ("): 3.25
Materials: **LFG**

878 TAB VG

Side Flexing



Widths ("): 3.25
Materials: **NGD**

878 TAB GS

Side Flexing



Widths ("): 3.25
Materials: **LFG** **NGG**

LBP 882 TAB

Side Flexing



Widths ("): 3.75, 4.5, 7.5, 10, 12
Materials: **LFG**

LBP 2120, LBP 2251

Straight Running



Widths ("): 3.35 thru 134
Materials: **LFG**

879 TAB VG

Side Flexing



Widths ("): 3.25, 4.5
Materials: **NGD**

1873 GS

Side Flexing

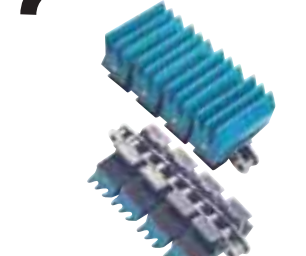

Widths ("): 3.25, 4.5
Materials: **LFG** **NGG**

Multiflex Chains

Great for dairy industry applications

Plate Top Chains

Higher chain load than plastic models

Crate Chains

Ideal for plastic case or crate handling

1700

Multiflex Chains



Materials: W LFW LF NG

843, 863

Straight Running



843 Widths ("): 1, 1.25, 1.375, 1.4375, 2, 3.25

863 Widths ("): 3.25, 4.5, 6, 7.5

Materials: LF XPG NG

CC 600, CC 600 TAB

Side Flexing



Materials: W NG

1701 TAB, 1701 TAB OP

Multiflex Chains



Materials: LFW LF NG

1843, 1863

Side Flexing

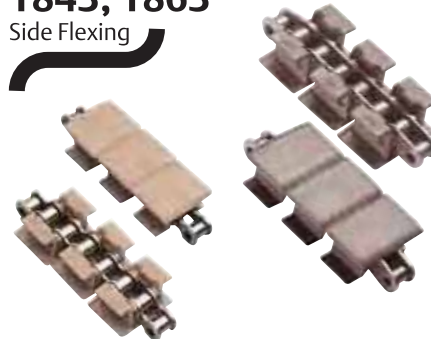

1843 Widths ("): 1.25, 2 1863 Width: 2.25

Materials: LF XPG NG

CC 1400, CC 1400 TAB

Side Flexing



Materials: W NG

1702

Multiflex Chains



Materials: W LFW LF NG

1873

Side Flexing

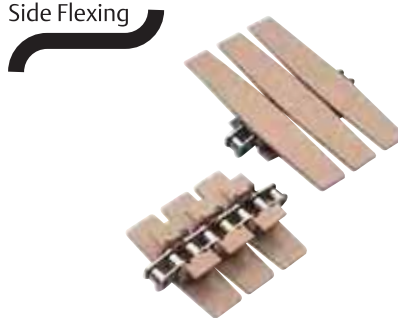

Widths ("): 2.25, 3.25, 4.5, 6, 7.5, 10, 12

Materials: LF XPG NG

CC 1431 TAB

Side Flexing

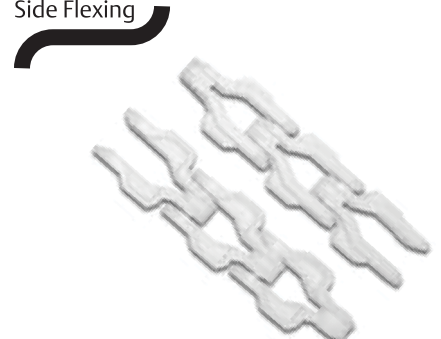

Materials: W NG

Modular Belts & Chain Belts

1/2" Pitch, 2121 FT

Single & Modular Widths, Straight Running

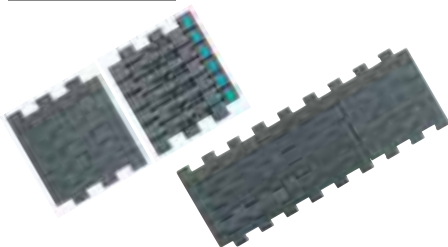

Single Widths ("): 3, 3.25, 4.5, 6, 7.5

Modular Widths ("): 9 thru 120 (various)

Materials: **LFG** **XPG** **NGG**

3/4" Pitch, 2190 FT

Single & Modular Widths, Straight Running

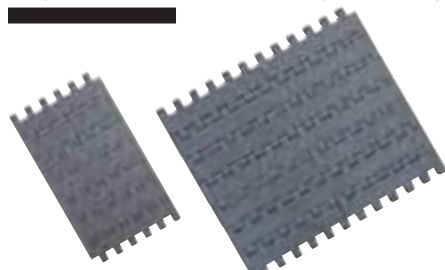

Single Widths ("): 3, 3.25, 4.5, 6, 7.5

Modular Widths ("): 9 thru 120 (various)

Materials: **LFG** **XPG** **NGG**

3/4" Pitch, 2190 FG

Single & Modular Widths, Straight Running

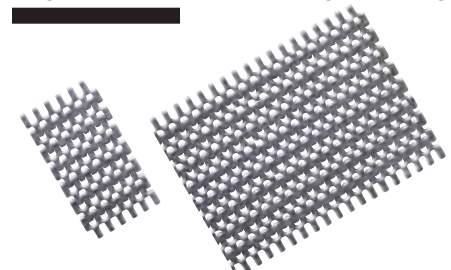

Single Widths ("): 3, 3.25, 4.5, 6, 7.5

Modular Widths ("): 9 thru 120 (various)

Materials: **LFG** **XPG** **NGG**

1" Pitch, 2253 FT

Modular Widths, Straight Running

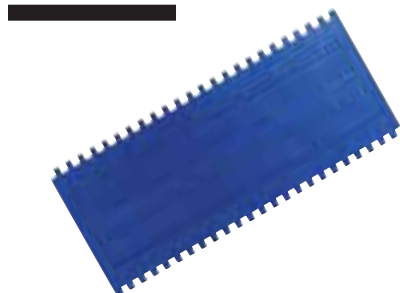

Modular Widths ("): 3 thru 120 (various)

Materials: **LFB**

1" Pitch, 2252 FT

Single Widths, Straight Running

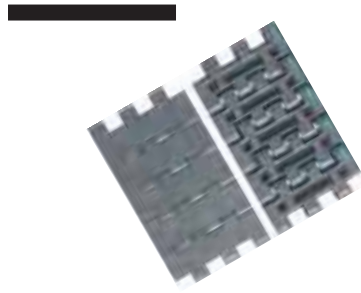

Single Widths ("): 3, 3.25, 4.5, 6, 7.5

Materials: **LFG** **XPG** **NGG**

1" Pitch, 2252 FT/2252 FG

Modular Widths, Straight Running

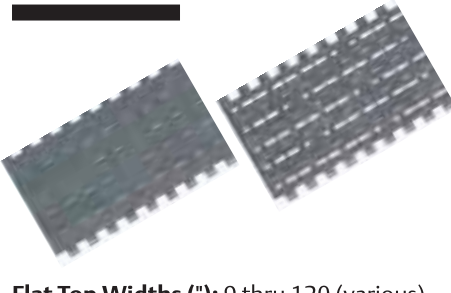

Flat Top Widths ("): 9 thru 120 (various)

Flush Grid Widths ("): 3 thru 120 (various)

Materials: **LFG** **XPG** **NGG**

1" Pitch, 2250 TAB Chain Belt

Side Flexing



Widths ("): 3.3, 4.5

Materials: **LFG** **XPG** **NGG**

1" Pitch, 2250 M Chain Belt

Side Flexing



Widths ("): 3.3

Materials: **LFG** **XPG** **NGG**

1" Pitch, 2251 TAB Chain Belt

Side Flexing

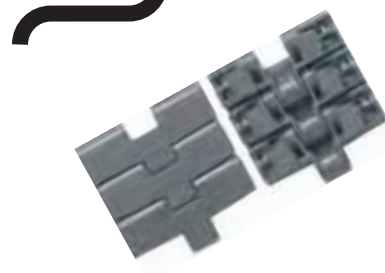

Widths ("): 3.3, 4.5

Materials: **LFG** **XPG** **NGG**

Modular plastic belts are offered in multiple pitches and widths for design flexibility. Imperial and metric varieties provide global solutions.

1" Pitch, 2251 M Chain Belt

Side Flexing



Widths ("): 3.3, 4.5

Materials: **LFG** **XPG** **NGG**

1" Pitch, 2260 M Chain Belt

Side Flexing



Widths ("): 3.3, 4.5

Materials: **LFG** **XPG** **NGG**

1/2" Pitch, 2120 FT

Single & Modular Widths, Straight Running

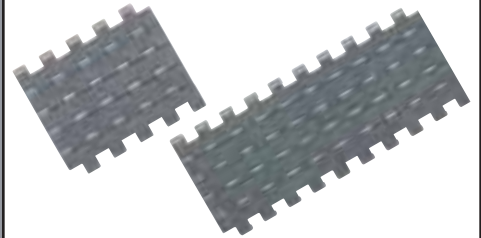

Single Widths: 83.8mm (3.30")

Modular Widths: 85mm thru 3400 (various)

Materials: **LFG** **XPG** **NGG**

1/2" Pitch, 2120 FT

Single & Modular Widths w/ Transfer Wing
Straight Running

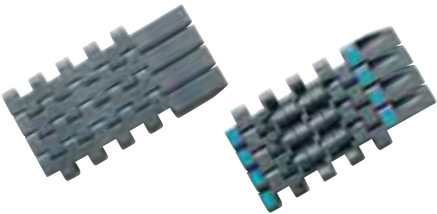

Single Widths: 83.8mm (3.30")

Modular Widths: 85mm thru 3400 (various)

Materials: **LFG** **XPG** **NGG**

1/2" Pitch, 2120 FG

Modular Widths, Straight Running



Modular Widths: 85mm thru 3400 (various)

Materials: **LFG** **XPG** **NGG**

1/2" Pitch, 2122 FG

Modular Widths, Straight Running

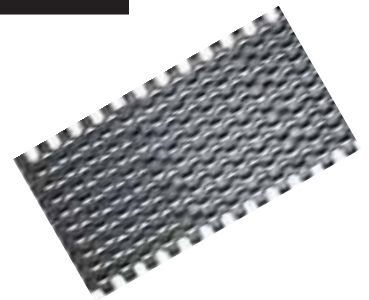

Modular Widths: 100mm thru 3000 (various)

Materials: **LFG** **XPG** **NGG**

1/2" Pitch, VG 2120

Single & Modular Widths, Straight Running

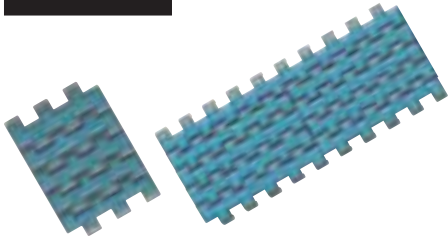

Single Widths: 34mm, 51mm

Modular Widths: 85mm thru 2380 (various)

Materials: **LFG**

1/2" Pitch, LBP 2120

Modular Widths, Straight Running

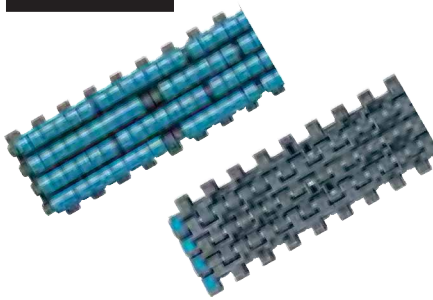

Modular Widths: 85mm thru 3400 (various)

Materials: **LFG**

1" Pitch, 2250 FT

Single & Modular Widths, Straight Running

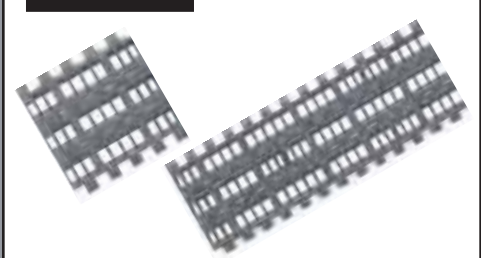

Single Widths: 83.8mm (3.30")

Modular Widths: 85mm thru 3400 (various)

Materials: **LFG** **XPG** **NGG**

Modular Belts & Sprockets

Additional metric width belts are shown below including the heavier duty 2251 series. A wide selection of molded or machined sprockets & idlers completes our offering.

1" Pitch, 2250 FG

Single & Modular Widths, Straight Running

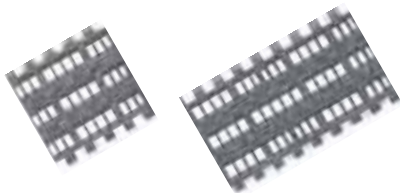

Single Widths: 83.8mm (3.30")

Modular Widths: 85mm thru 3400 (various)

Materials: LFG XPG NGG

1" Pitch, 2250 FT/FG

Single & Modular Widths w/ Transfer Wing
Straight Running

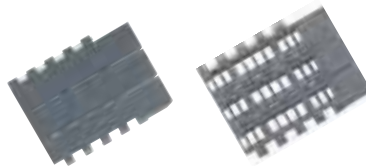

Single Widths: 83.8mm (3.30")

Modular Widths: 85mm thru 3400 (various)

Materials: LFG XPG NGG

1" Pitch, VG 2250

Single & Modular Widths, Straight Running

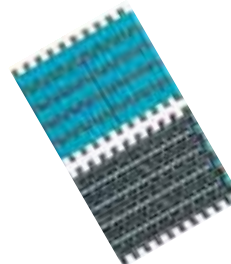

Modular Widths: 85mm thru 2380 (various)

Materials: LFG

1" Pitch, 2251 FT

Single & Modular Widths, Straight Running

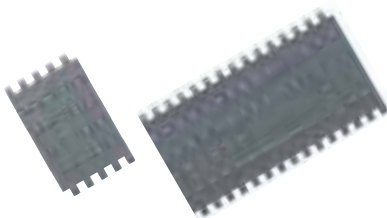

Single Widths: 83.8mm (3.30")

Modular Widths: 85mm thru 3400 (various)

Materials: LFG XPG NGG

1" Pitch, VG 2251

Modular Widths, Straight Running

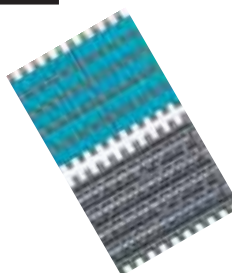

Modular Widths: 85mm thru 2380 (various)

Materials: LFG

1" Pitch, 2251 LBP

Single & Modular Widths, Straight Running

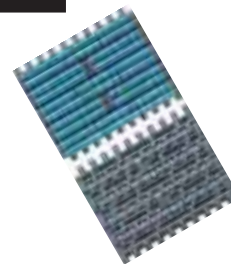

Single Widths: 51mm (2")

Modular Widths: 85mm thru 3400 (various)

Materials: LFG

2" Pitch, RR2500

Modular Widths, Straight Running



Modular Widths: 9" thru 150" (various)

Materials: PPG LFG

Sprockets & Idlers



Series: Chain and Modular Belt

Materials: White or Black Polyamide

Idler Wheels



Series: Chain and Modular Belt

Materials: White or Black Polyamide

What are Nolu® Plastics?

Nolu® plastics are SystemPlast™ exclusive compounds of UHMW and solid lubricants/unique ingredients. They provide reduced coefficients of friction while maintaining the characteristics of UHMW. Our featured materials are Nolu-S, Nolu-SR and Nolu-SX.

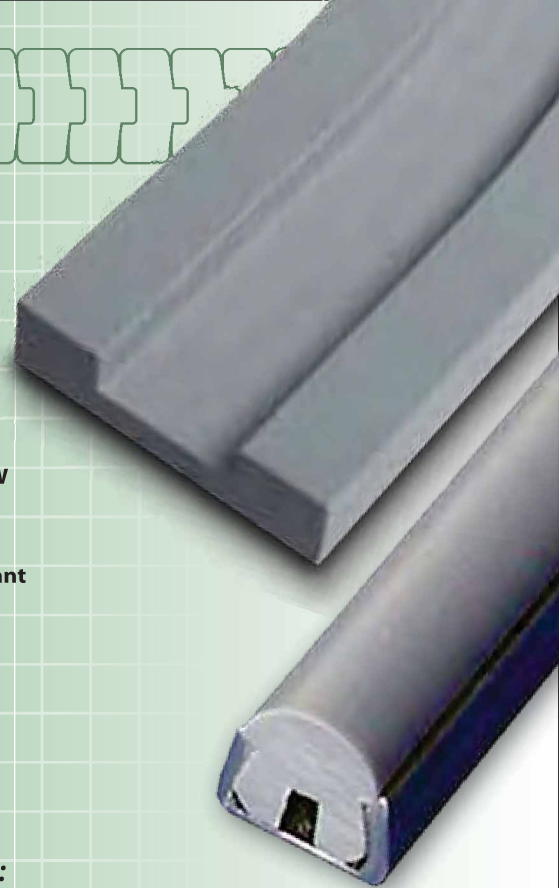
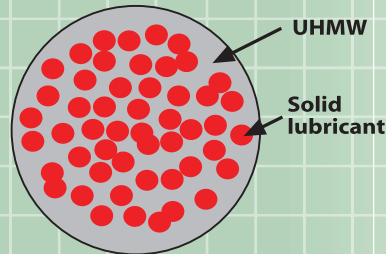

Nolu-S

Features:

- Extruded or machined
- Very low coefficient of friction - promotes material flow
- High-impact strength
- Chemical resistant with minimal moisture absorption
- FDA & USDA approved ingredients
- Noise suppressant
- Easy to machine – most general power tools are sufficient

Benefits:

- Extends the life of mating surfaces
- Lowers mating surface scratching or damage
- Reduces energy consumption
- Minimizes product pulsation on conveyors
- Low noise operation

Nolu-SR

Nolu-SR has the same unique self-lubricating properties as Nolu-S, however, it also contains additional proprietary ingredients. These unique ingredients increase the hardness of the material, providing superior wear resistance as compared to standard UHMW. Benefits of Nolu-SR include high wear resistance, extended wear life, minimization of product pulsation and low noise.

Features:

- Extruded or machined
- Superior wear resistance – greater than standard virgin or repro material
- Low coefficient of friction - promotes material flow
- High-impact strength
- Chemical resistant with minimal moisture absorption
- FDA & USDA approved ingredients
- Easy to machine – most general power tools are sufficient

Benefits:

- High wear resistance
- Extends the life of mating surfaces
- Lowers mating surface scratching or damage
- Reduces conveyor chain loads or damage
- Reduces energy consumption
- Reduces product pulsation on conveyors
- Low noise operation
- Suitable for running dry at higher speed

Nolu-SX

Nolu-SX has the same unique self-lubricating properties as Nolu-S, however, Nolu-SX has a material blend that reduces the thermal expansion characteristics of the material. The thermal expansion is reduced up to 40% compared to standard UHMW products, making it the ideal material for neck guides.

Nolu® Plastics should be stored at room temperature between 40°F (5°C) and 95°F (35°C) to prevent premature aging of the material. They should also be stored in a manner to prevent distortion. Regular cleaning is also recommended with warm water & soap agents with a pH value of 4.5 to 9.0. For more technical information regarding Nolu materials, please contact our Application Engineering Group.



Components

System Plast™ offers one of the largest conveying component lines in the market featuring our exclusive Valu Guide® brand guide rail and accessories. Our extensive component offering provides all of the quality products needed to properly assemble, support and guide conveyor systems and products. Our almost limitless choice of innovative solutions make it possible to arrange conveying systems for the most diverse production requirements. Highlights of our offering include:

Guide Rail - Valu Guide guide rail features stainless steel sheaths and high quality inserts. Insert materials are available in multiple materials including UHMW, our exclusive low friction Nolu-S, and static dissipative UHMW. All materials are FDA and USDA accepted allowing for use in almost any application.

Brackets and Positioning - rail clamps, clips, plastic and metal guide rail brackets, knobs and cross blocks provide endless holding combinations. Our SpeedSet™ brackets also offer quicker size change adjustments.

Corner Tracks & Wearstrips – Our unique ValuTrac™ corner tracks are offered in 3 styles in addition to our custom magnetic tracks. Wear strips, bar caps, bar covers, and J-Leg wear products create the perfect run surface for long running chains and belts.

Bead and Roller Guides - Exclusive SpeedRail, SpeedRoll, BeadRail, and BeadWall low friction guide products enable improved product flow for merges and product lane dividers.

Frame and Support Components – threaded tube ends, levelers, vibration pads, bipods & tripods, post caps and side mount brackets provide strong structural support and adjustability.

Mounted Bearings and Accessories – Flange, pillow block, tapped and solid flange bearings for worry free operation.

Rollers and return products – Roll-Tech gravity conveyors, return rollers, roller end bearings, plus custom engineered plastic rollers provide versatile conveying capabilities.

System Plast Custom Machined Plastics – System Plast has an expert engineering and machining staff to design and produce high quality plastic products built to your specifications.

ValuGuard™ - Custom Machine Guarding and Standard Enclosure Products can provide a cleaner or safer work environment.



Our ValuTrac™ and magnetic corner tracs provide industry leading features for conveyor curves in addition to unique material selections.

Turning Disks



Materials: Polyamide

ValuTrac™



Materials: Nolu-BR, Nolu-S, Nolu-SR,

ValuTrac™ II and III



Materials: Nolu-BR, Nolu-S, Nolu-SR,

Magnetic Corner Tracks

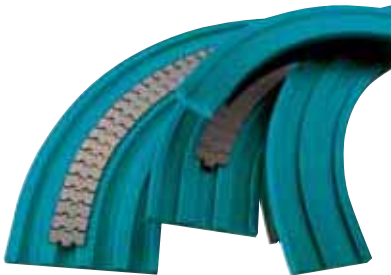

Materials: UHMW-PE, Nolu-S, Nolu-SR

Safe Transfer Modules



Materials: UHMW-PE

Modular Transfer Plates



Frame Materials: Acetal
Bead or Roller Materials: Acetal, Stainless Steel

Serpentine Chain Return Systems



Component Materials: UHMW, Acetal, Stainless Steel

Chain Return Shoe



Materials: Black Polyamide

Chain Guide Wear Strip



Component Materials: Stainless Steel, Black Polyamide, Green UHMW

Our Valu Guide® products provide one of the largest selections of guide products available. Multiple material extrusions and unique roller guide products can also provide increased production throughput.

Valu Guide® Rails



Materials: UHMW, Nolu-S, Static Dissipating, PTFE hi-temp

Clips and Clamps



Materials: Stainless Steel, Polyamide, Acetal

Bar Caps and Covers



Materials: UHMW, Nolu-S, Nolu-SR, Static Dissipative

J-Legs and Wearstrips

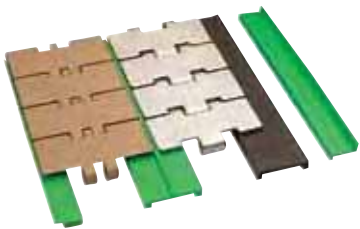

Materials: UHMW, Nolu-S, Nolu-SR, Static Dissipating

Extrusions and Inserts

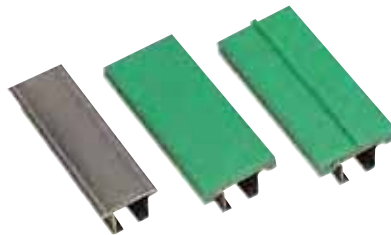

Extrusion Materials: Aluminum
Insert Materials: UHMW, Nolu-S, Nolu-SR, Static Dissipative

Bead and Roller Guides



Channel Materials: Aluminum, PVC
Bead or Roller Materials: Acetal

Flexible Roller Modules



Strap Materials: Polyamide
Bead or Roller Materials: Acetal

Flexible Roller Modules



Strap Materials: Polyamide
Bead or Roller Materials: Acetal

Side and Nose Plows



Materials: Acetal, Nolu-S

Multiple types and sizes of bracketry are offered to ensure design flexibility for a wide range of conveying needs. Our SpeedSet™ brackets also offer great time savings during product size changeovers.

SpeedSet™ Brackets



Materials: Polyamide Bracket, Stainless Steel Rod, PVC Push Knob

Plastic Brackets



Materials: Polyamide

Metal Brackets



Materials: Stainless Steel

Bracket Knobs



Materials: Polyamide

Bracket Spacers



Materials: Polyamide

Cross Blocks



Materials: Polyamide

Round Tube Ends



Materials: Polyamide with Brass Insert

Square Tube Ends



Materials: Polyamide with Brass Insert

SaniStar Levelers



Base Materials: Stainless Steel and Rubber
Stem Materials: Stainless Steel

Levelers are provided in a multitude of load capacities and material types including stainless steel. Structural post caps and mounting brackets provide strong and non-corroding frame support.

Light Duty Levelers



Base Materials: Reinforced Polyamide

Medium Duty Levelers



Base Materials: Reinforced Polyamide

Heavy Duty Levelers



Base Materials: Reinforced Polyamide

Solid Base Levelers



Base Materials: Reinforced Polyamide

Socket Style Levelers



Base Materials: Reinforced Polyamide

Solid Metal Base Levelers



Base Materials: Zinc plated or stainless steel

Vibration Pads



Materials: Neoprene rubber or metal and rubber

Post Caps



Materials: Polyamide

Side Mounting Brackets



Materials: Polyamide

Multiple support base styles and a large assortment of handles and hinges are provided. Mini gravity roller conveyors plus standard and custom rollers complement the offering.

Support Bases



Materials: Polyamide

Ratchet Handles



Handle Materials: Polyamide
Thread Materials: Black Oxide Coated Steel, Stainless Steel

Handles and Hinges



Materials: Polyamide

Roll-Tech Mini Conveyors

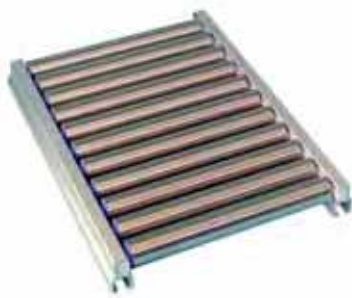

Side Channel Materials: Aluminum
Roller Materials: Aluminum or Stainless Steel

Return Rollers



Roller Materials: Green or Orange HDPE
Cover Materials: Thermoplastic Rubber

Rollers



Materials: PVC, Aluminum, UHMW, Stainless Steel, Carbon Steel, Urethane



Mounted Bearing Supports

Wide variety of wash down duty mounted bearing supports from 1/2" to 1 7/16"

Polyamide



Insert: AISI 52100, 400 Stainless Steel
Optional: End Cap and Back Seal

Nolu-Clean



Insert: AISI 52100, 400 Stainless Steel
Optional: End Cap and Back Seal

Stainless Steel



Insert: 400 Stainless Steel

Shaft Protector Bushing



Insert Materials: Nolu-S
Housings: Polyamide

Bearing Safety Caps



Materials: Polypropylene

Spherical and Self Aligning Bearings



Insert Materials: Nolu-S, UHMW
Housings: Carbon Steel or 304 Stainless Steel

Enclosure / Guard Systems

Standard and custom engineered high quality safety enclosures

ValuGuard™ Safety Enclosure Systems



Tube Material: Anodized Aluminum
Corner Material: Reinforced Polyamide

ValuGuard™ Machine Guarding



Tube Material: Stainless Steel or Aluminum
Corner Material: Aluminum or Polyamide

**SYSTEM
PLAST**

Keep your equipment and your business moving forward

The whole world is on the move today. Everything from people and products to ideas and information. That means business has to be on the move, as well. Power Transmission Solutions, a business of Emerson Industrial Automation, can help. We keep products and businesses moving forward. Whether it's helping to make sure that packages arrive on time, roads are built, energy is produced, food and beverages are processed, or luggage arrives at airport baggage areas, our products and solutions help make the world go.



Online Tools

Our ePT EDGE® Online industry-leading consultative website offers quick, concise and complete access to a wide range of support services, including:

- Smart interchange
- eCatalog
- Product selection
- Product literature
- CAD templates
- Engineered solutions
- EDGE JIT
- eLINK – a transaction tool for accessing data concerning:
 - Stock/price checks
 - Order entry
 - Shopping list (favorites)
 - Quote center
 - Order status
 - Shipment tracking



SysCalc Conveyor Calculation

The SysCalc program is a tool for conveyor designers to use to shorten the design process. This software was developed to simplify routine calculations and to give a guideline to the designer. It helps indicate whether the entered operating conditions or the layout is correct or if the expected service life of the chain is long enough. This enables a more efficient design process for the engineer.



Conveyor Solutions Calculator App

Compatible with tablet computers and smart phones, our Conveyor Solutions App allows quick calculations of cost reductions available from various choices of motors, drives and flat top conveyor chains. The App also provides the calculation of water/soap lubrication reductions as well as time savings from quick changeover guide rail brackets. Results are presented in kWh savings, annual cost savings, ROI, case throughput increase, and recaptured revenue.

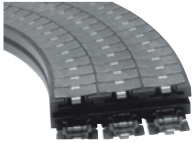

**SYSTEM
PLAST**

Conveying Chain



SEALMASTER

Mounted Ball Bearings



Morse

Clutches



Browning

Shaft Mount Reducers



SEALMASTER

Mounted Roller Bearings



ROLLWAY

Roller Bearings



Browning

V-Belt Drives



Morse

Chain



KOP-FLEX

Couplings



JAURE

Wind Couplings



Morse

Worm Gearing



McGILL

Precision Bearings

Regal Beloit Americas, Inc Power Transmission Solutions

Corporate Headquarters

Florence, KY 41042

(859) 342-7900

www.systemplast.com

www.regalpts.com/brands/system-plast

Distribuidor Oficial:



Rolamentos CBF Ltda.

Tel.: +55 (11) 3824-6400

E-mail: vendas@cbfcorp.com.br

www.rolamentoscdf.com.br

REGAL

**System Plast Conveyor Chain, Modular Belts and Components
MCB11009E • Form 9441E**

APPLICATION CONSIDERATIONS

The proper selection and application of power transmission products and components, including the related area of product safety, is the responsibility of the customer. Operating and performance requirements and potential associated issues will vary appreciably depending upon the use and application of such products and components. The scope of the technical and application information included in this publication is necessarily limited. Unusual operating environments and conditions, lubrication requirements, loading supports, and other factors can materially affect the application and operating results of the products and components and the customer should carefully review its requirements. Any technical advice or review furnished by Regal Power Transmission Corporation and its divisions with respect to the use of products and components is given in good faith and without charge, and Regal assumes no obligation or liability for the advice given, or results obtained, all such advice and review being given and accepted at customer's risk.

For a copy of our Standard Terms and Conditions of Sale, Disclaimers of Warranty, Limitation of Liability and Remedy, please contact Regal Power Transmission Customer Service at 1-800-626-2120. These terms and conditions of sale, disclaimers and limitations of liability apply to any person who may buy, acquire or use an Regal Power Transmission Corporation product referred to herein, including any person who buys from a licensed distributor of these branded products.

Regal Power Transmission does not warrant the accuracy of the information contained in this document. All interchanges should be compared with actual current specifications and/or manufacturing drawings. For a copy of our standard terms and conditions, contact Regal Power Transmission at 1-800-626-2120.

Regal, Regal. Consider It Solved., and System Plast are trademarks of Regal Beloit Co. or one of its affiliated companies.

©2012 Regal Power Transmission Corp., All Rights Reserved. MCB11009E • Form 9441E • Printed in USA